

### SKF 71903 CE/HCP4AH参数

主要尺寸	d	17	mm	-
	D	30	mm	-
	B	7	mm	-
基本额定载荷	C	3320	N	动载荷
	$C_0$	1560	N	静载荷
疲劳载荷极限	$P_u$	67	N	-
可达转速	Grease	83000	r/min	-
	Oil-air	127000	r/min	-
重量	重量	14	g	-
型号	型号	71903 CE/HCP4AH	-	-

### SKF 71903 CE/HCP4AH图片

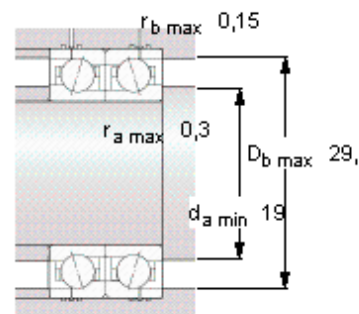
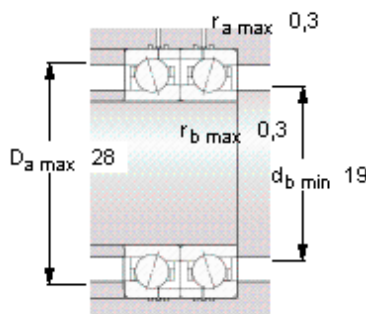
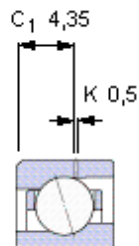
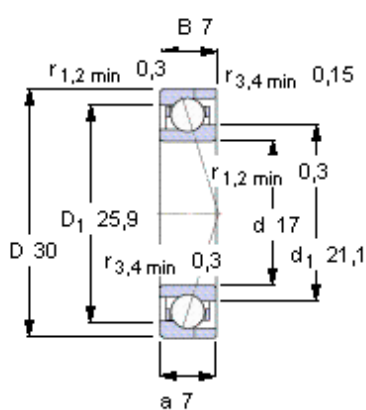

**Ball diameter** 3,969

**Number of balls** 13

**未安装时的预载荷 [N]**

背对背配置，面对面配置

预载荷等级

A	B	C	D
18	54	108	-

**Static axial stiffness [N/μm]**

(guideline value)

预载荷等级

A	B	C	D
16	25	34	-

**Reference grease quantity [cm<sup>3</sup>]**

$G_{ref}$  0,2

**计算系数**

for equivalent bearing load

$f_0$  7,9

for preload in mounted bearing sets

f 1,05

$f_1$  1

$f_{2A}$  1

$f_{2B}$  1,05

$f_{2C}$  1,09

$f_{2D}$  -

$f_{HC}$  1,01

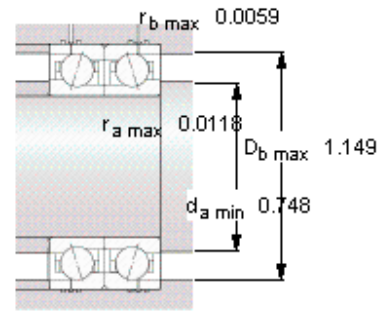
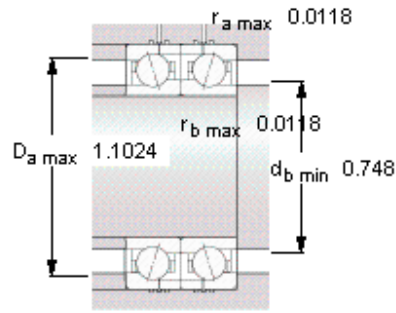
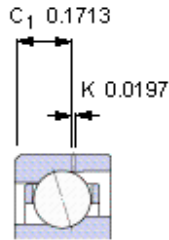
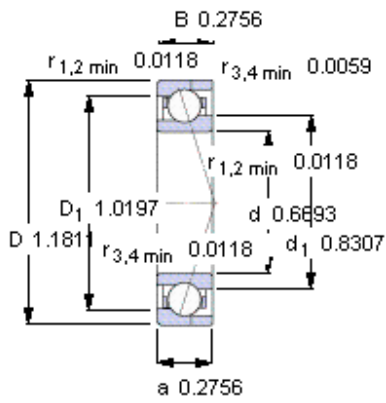

**Ball diameter** 3,969  
**Number of balls** 13

**未安装时的预载荷 [N]**

背对背配置，面对面配置

预载荷等级

A	B	C	D
18	54	108	-

**Static axial stiffness [N/μm]**

(guideline value)

预载荷等级

A	B	C	D
16	25	34	-

**Reference grease quantity [cm<sup>3</sup>]**

G<sub>ref</sub> 0,2

**计算系数**

for equivalent bearing load

f<sub>0</sub> 7,9

for preload in mounted bearing sets

- f 1,05
- f<sub>1</sub> 1
- f<sub>2A</sub> 1
- f<sub>2B</sub> 1,05
- f<sub>2C</sub> 1,09
- f<sub>2D</sub> -
- f<sub>HC</sub> 1,01