

TIMKEN 180RU91参数

轴承型号	Part Number	180RU91		-
	Subtype	NU		-
尺寸	d	180	mm	内径
	D	279.999	mm	外径
	B	82.6008	mm	宽度
额定载荷	C1	511545	N	一百万转动态径向载荷
	C0	627199	N	静态额定载荷
几何结构系数	Cg	0.1637		几何系数
极限转速	oil	2700		润滑油
	grease	2100		润滑脂
尺寸	R	2.54	mm	最大轴肩倒角半径
	da	197.104	mm	轴肩直径
	r	2.54	mm	最大轴承座挡肩圆角半径
	Da	261.874	mm	轴承座挡肩直径
重量	Assembly Weight	19459.11	g	-

TIMKEN 180RU91图片

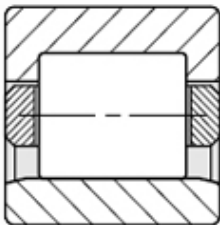
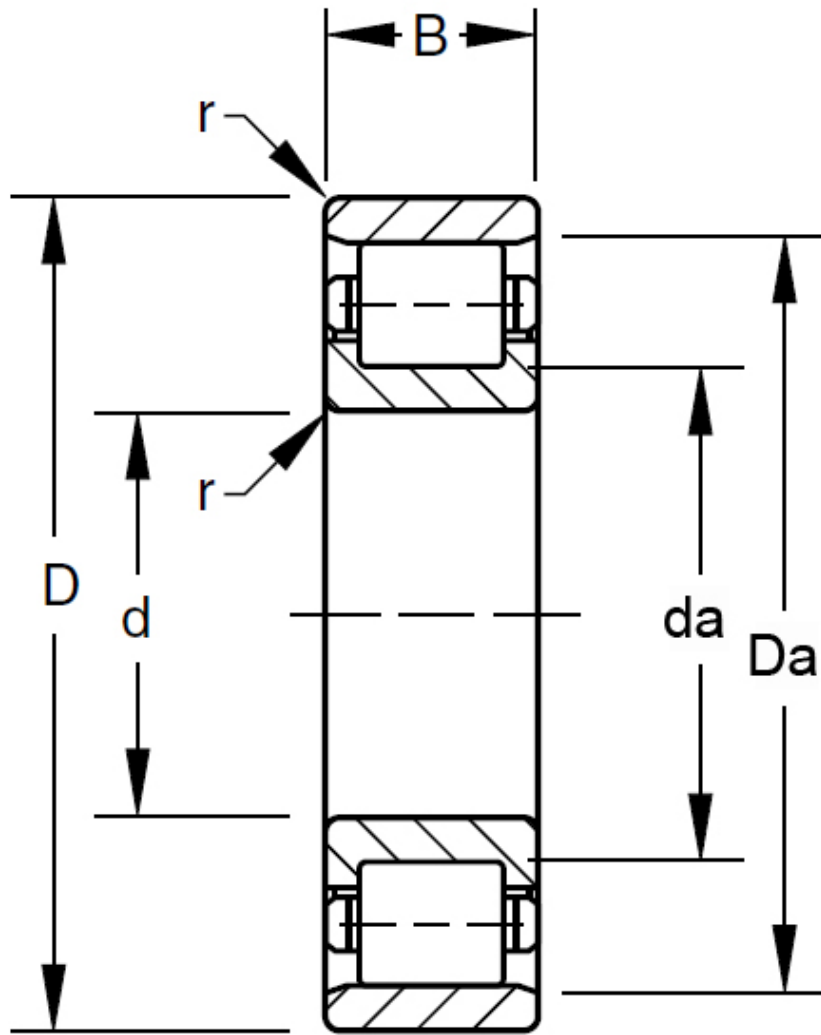

RU
RIU

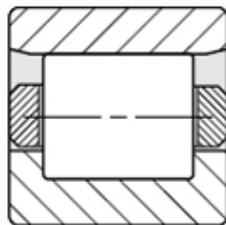

RN
RIN

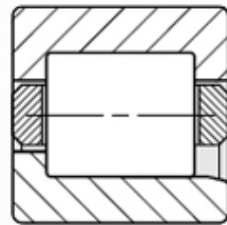

RJ
RIJ

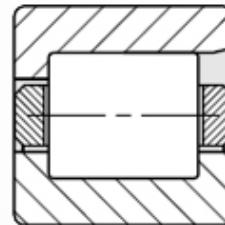

RF
RIF

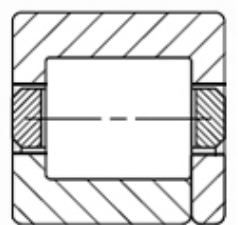

RT
RIT

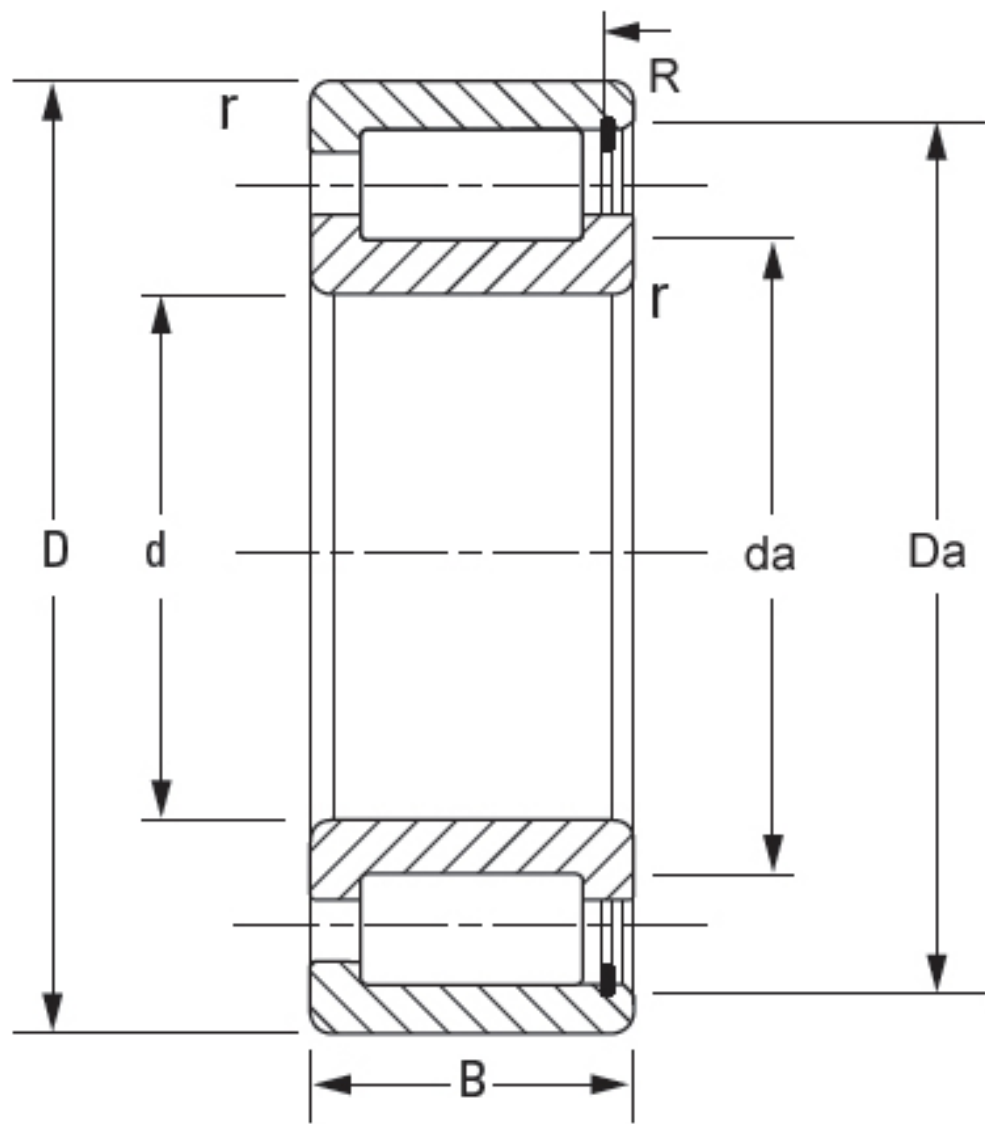

NCF