

SKF 71924 CD/HCP4AH1参数

主要尺寸	d	120	mm	-
	D	165	mm	-
	B	22	mm	-
基本额定载荷	C	78000	N	动载荷
	C_0	91500	N	静载荷
疲劳载荷极限	P_u	3250	N	-
可达转速	Grease	9000	r/min	-
	Oil-air	14000	r/min	-
重量	重量	990	g	-
型号	型号	71924 CD/HCP4AH1	-	-

SKF 71924 CD/HCP4AH1图片

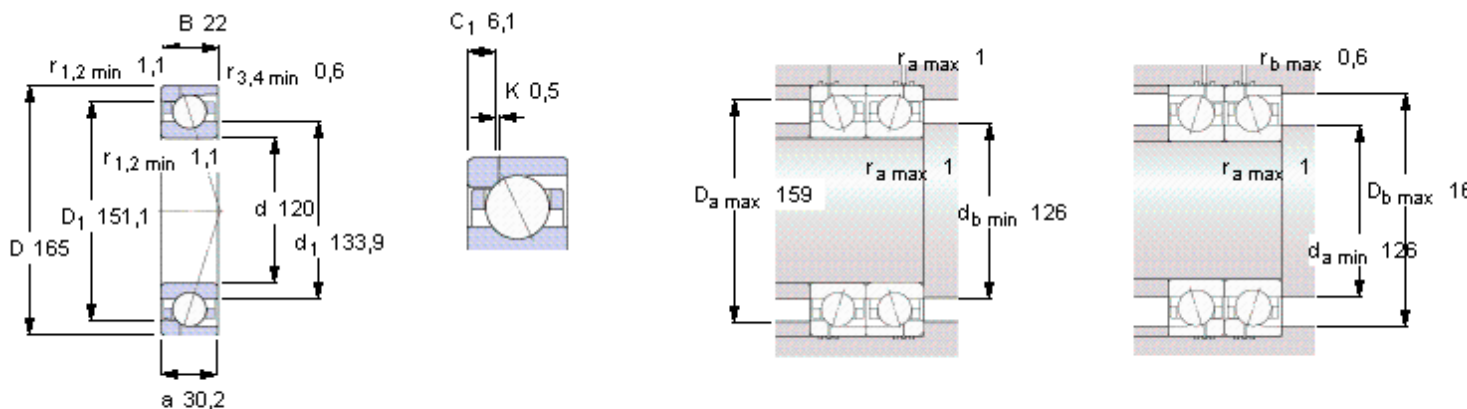

Ball diameter 14,288

Number of balls 28

未安装时的预载荷 [N]

背对背配置，面对面配置

预载荷等级

A	B	C	D
290	580	1160	2320

Static axial stiffness [N/μm]

(guideline value)

预载荷等级

A	B	C	D
141	193	273	401

Reference grease quantity [cm³]

G_{ref} 15

计算系数

for equivalent bearing load

f_0 16,5

for preload in mounted bearing sets

f 1,26

f_1 1

f_{2A} 1

f_{2B} 1,07

f_{2C} 1,12

f_{2D} 1,18

f_{HC} 1,04

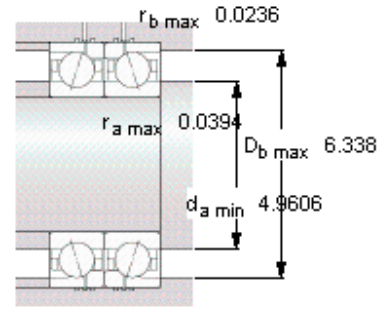
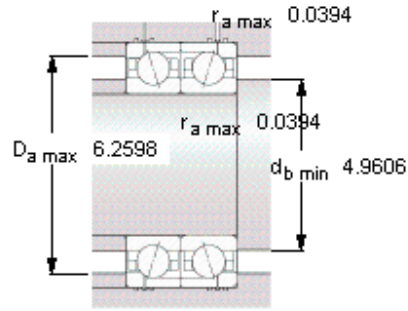
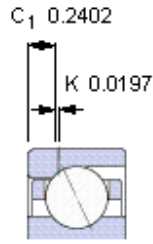
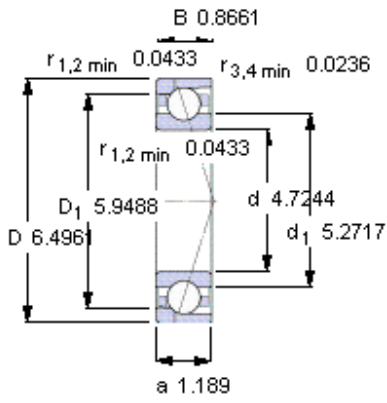

Ball diameter 14,288

Number of balls 28

未安装时的预载荷 [N]

背对背配置，面对面配置

预载荷等级

A	B	C	D
290	580	1160	2320

Static axial stiffness [N/μm]

(guideline value)

预载荷等级

A	B	C	D
141	193	273	401

Reference grease quantity [cm³]

G_{ref} 15

计算系数

for equivalent bearing load

f₀ 16,5

for preload in mounted bearing sets

f 1,26

f₁ 1

f_{2A} 1

f_{2B} 1,07

f_{2C} 1,12

f_{2D} 1,18

f_{HC} 1,04