

SKF S71910 CD/HCP4A参数

主要尺寸	d	50	mm	-
	D	72	mm	-
	B	12	mm	-
基本额定载荷	C	13500	N	动载荷
	C_0	10400	N	静载荷
疲劳载荷极限	P_u	440	N	-
可达转速	Grease	22000	r/min	-
	Oil-air	-	r/min	-
重量	重量	120	g	-
型号	型号	S71910 CD/HCP4A	-	-

SKF S71910 CD/HCP4A图片

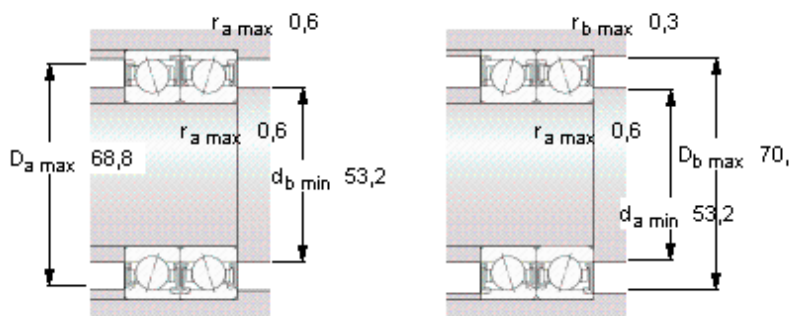
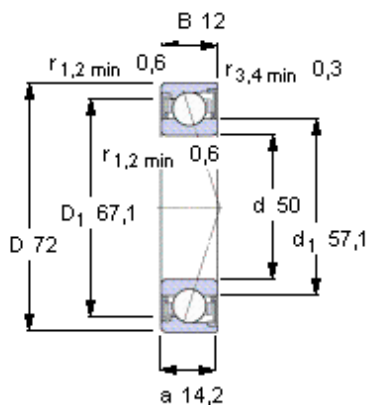

Ball diameter 6,35
Number of balls 25

未安装时的预载荷 [N]
背对背配置，面对面配置
预载荷等级

A	B	C	D
50	100	200	400

Static axial stiffness [N/μm]
(guideline value)

预载荷等级

A	B	C	D
47	63	87	122

Reference grease quantity [cm³]
 G_{ref} -

计算系数
for equivalent bearing load
 f_0 10,7

for preload in mounted bearing sets
f 1,13
 f_1 1
 f_{2A} 1
 f_{2B} 1,07
 f_{2C} 1,12
 f_{2D} 1,18
 f_{HC} 1,04

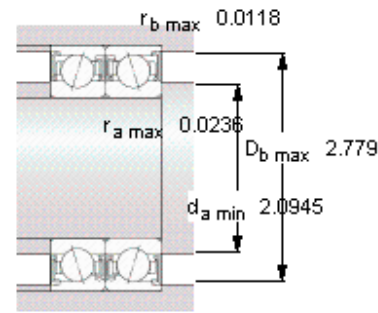
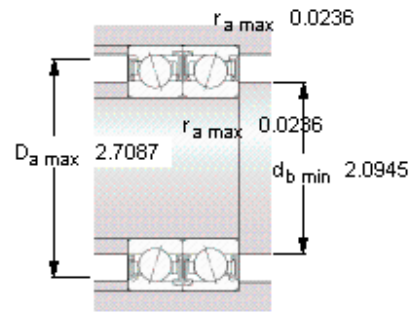
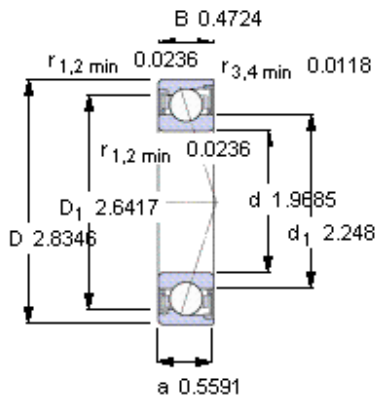

Ball diameter 6,35

Number of balls 25

未安装时的预载荷 [N]

背对背配置，面对面配置

预载荷等级

A	B	C	D
50	100	200	400

Static axial stiffness [N/μm]

(guideline value)

预载荷等级

A	B	C	D
47	63	87	122

Reference grease quantity [cm³]

G_{ref} -

计算系数

for equivalent bearing load

f₀ 10,7

for preload in mounted bearing sets

f 1,13

f₁ 1

f_{2A} 1

f_{2B} 1,07

f_{2C} 1,12

f_{2D} 1,18

f_{HC} 1,04